

Ø113mm 500W

B14 BN63 - NV

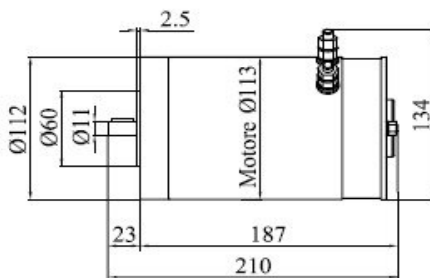

B14 BN63 - NV - FMT

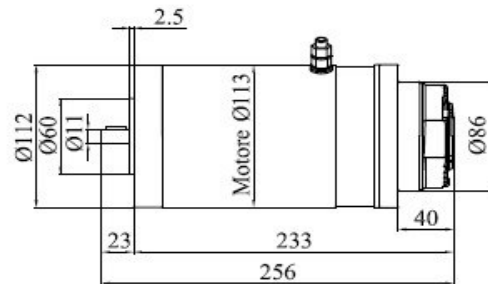

B14 BN71 - NV

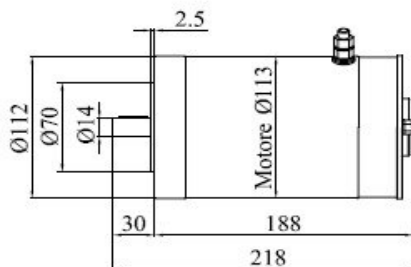

B14 BN71 - NV - FMT

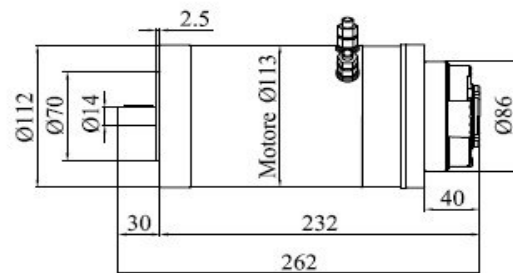

B5 BN63 - NV

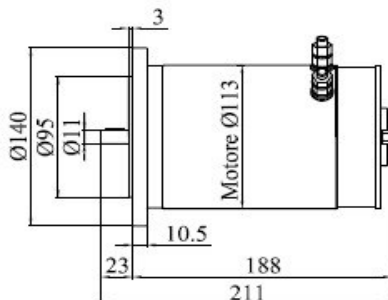

B5 BN63 - NV - FMT

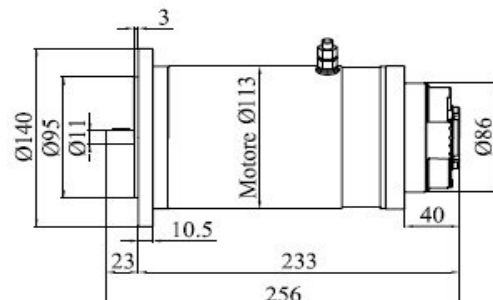

B5 BN71 - NV

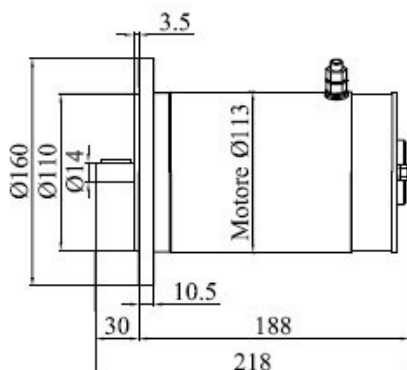

B5 BN71 - NV - FMT

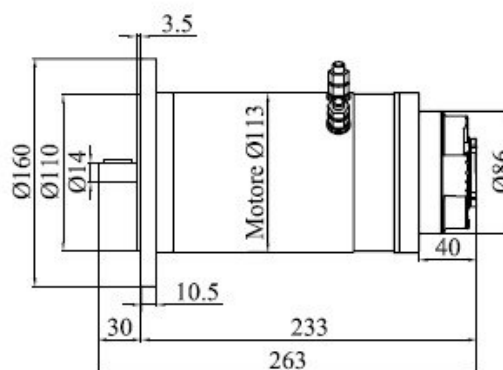

500W ECCITAZIONE IN SERIE – SERIES EXCITATION

Tensione Voltage	Giri Round	Coppia Torque
V	Rpm/min	Nm
12	2500	1.9
24	2850	1.7
36	2800	1.7
48	2800	1.7

A richiesta i motori possono essere disponibili con eccitazione separata, composta o parallela.
On request motors are available with separate, compound or shunt excitation.

500W MAGNETI PERMANENTI – PERMANENT MAGNETS

Tensione Voltage	Giri Round	Coppia Torque
V	Rpm	Nm
12	2500	1.9
24	2850	1.7
36	2800	1.7
48	2800	1.7