

View from "A"
OUTLET

View from "B"
INLET

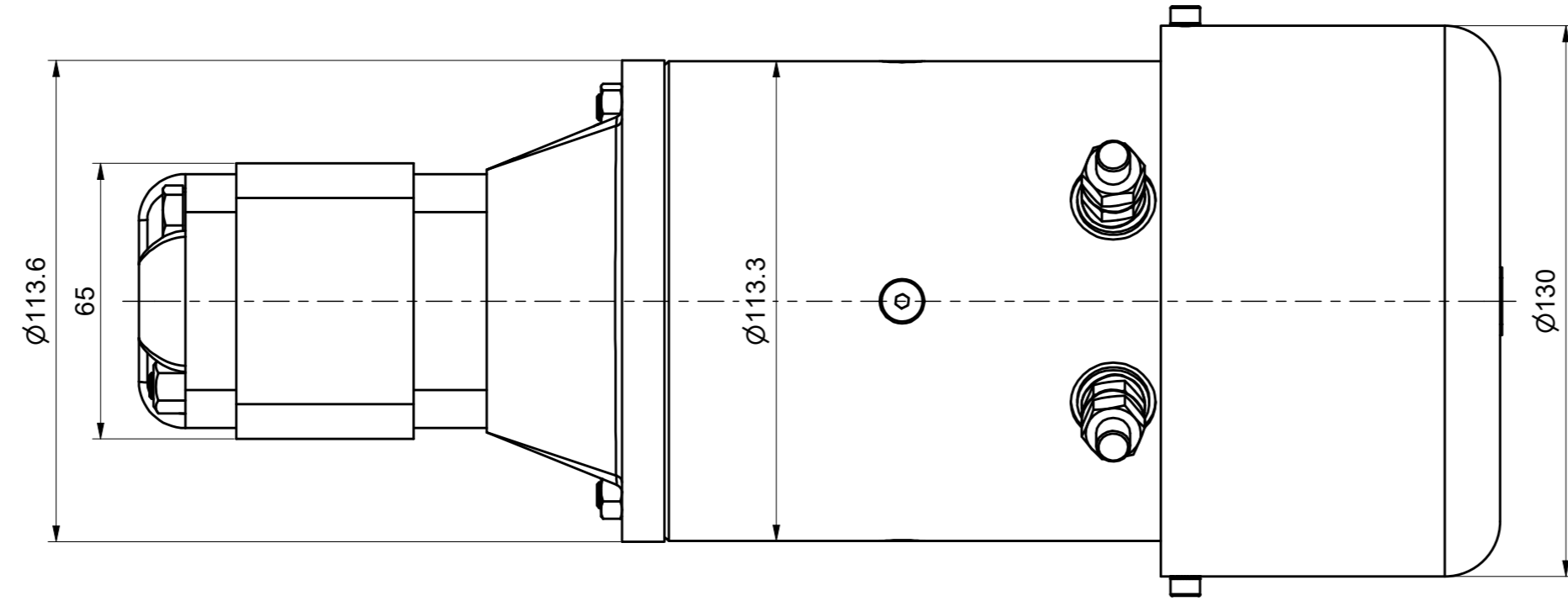
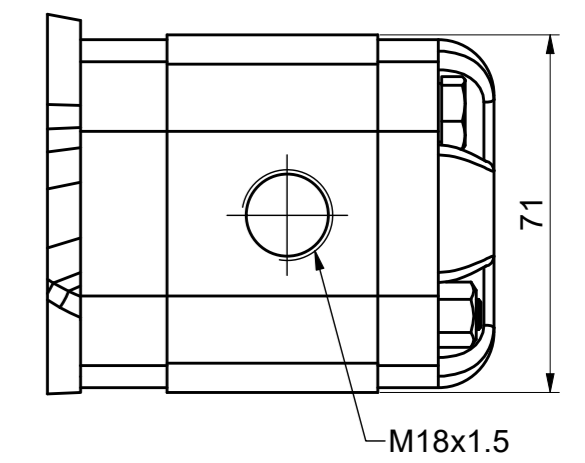
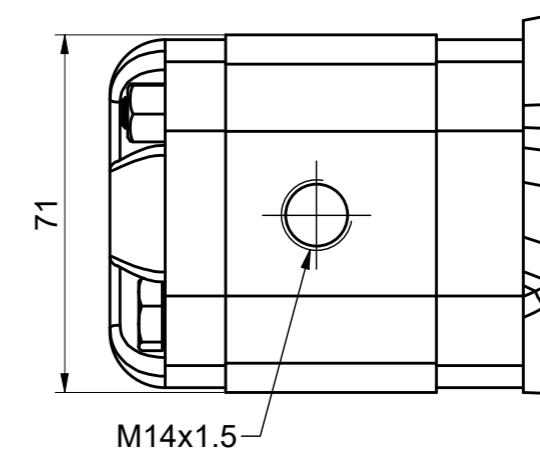

Displacement [cm ³ /rev]	Flow (at 1500 rpm) [litres/min]	Max pressure			Max speed [rpm]	Dimensions		
		p _{continuous} [bar]	p _{intermittent} [bar]	p _{peak} [bar]		A [mm]	B [mm]	C [mm]
1.1	1.6	230	250	270	6000	76	35	315
1.6	2.4	230	250	270	6000	78	36	317
2.1	3.2	230	250	270	6000	80	37	319
3.2	4.8	210	230	250	5000	84	39	323
3.7	5.6	210	230	250	4500	86	40	325
4.2	6.4	210	230	250	4000	88	41	327
5.8	8.7	190	210	230	3000	94	44	333
8.0	11.9	160	180	200	2100	102	48	341