

View from "A"

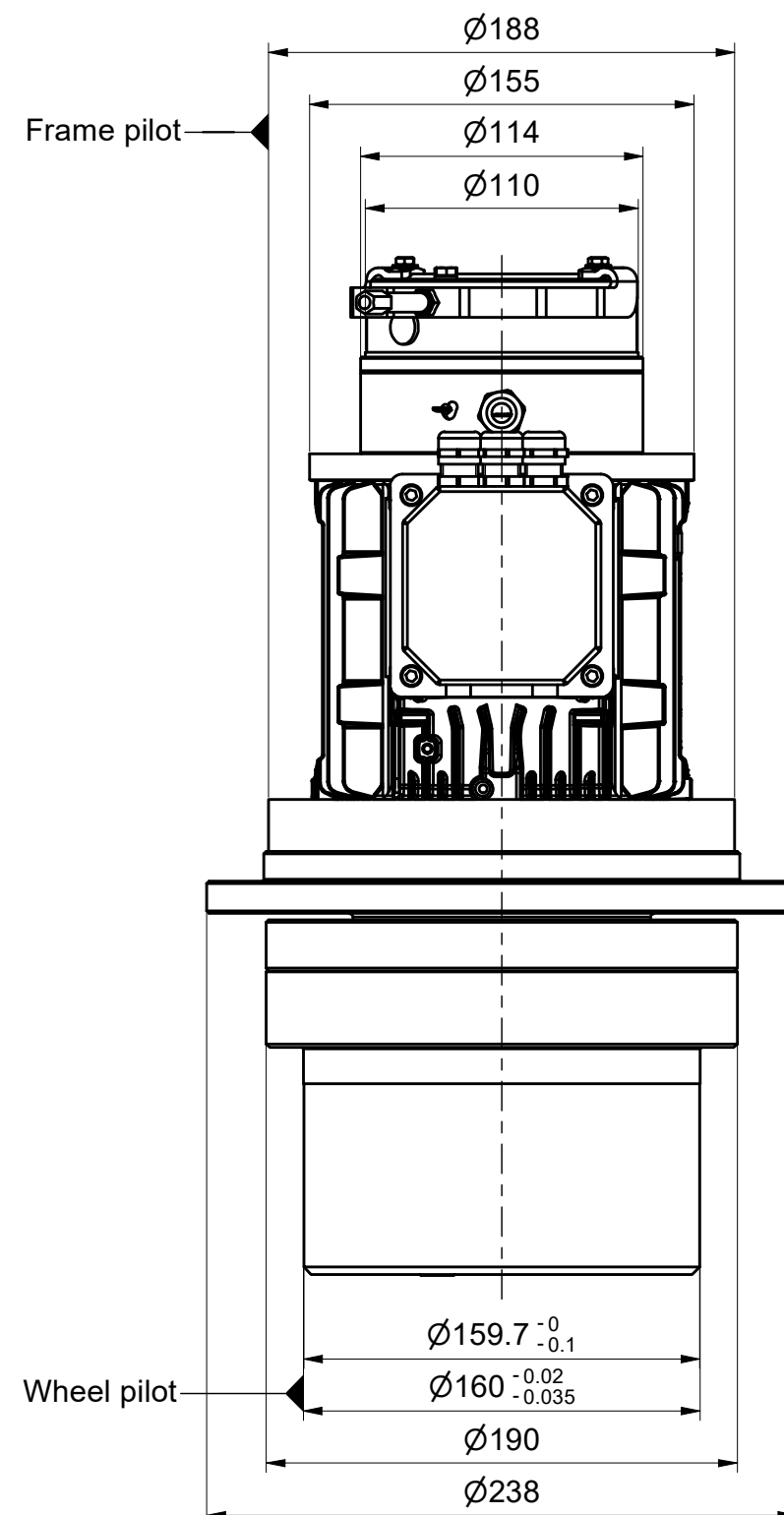
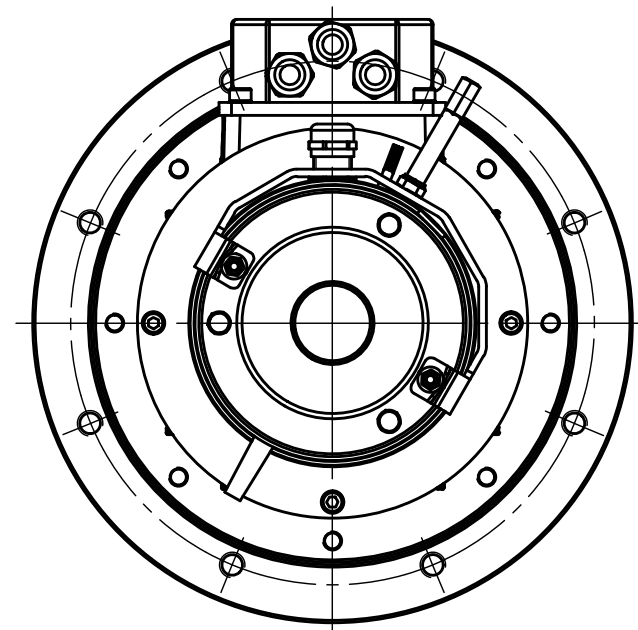

Bearing static load rating C1=C2= 190 kN

Bearing dynamic load rating C1=C2= 154 kN

Gear Technical Data

Reduction ratio	i	30.33:1
Permitted output torque	Nm	1800
Max radial load	kg	2300
Lubrication		Oil
Brake torque	Nm	10